



# ARTÍCULOS PROMOCIONALES

**CATÁLOGO**



**PROMOTIER**<sup>®</sup>

Promocionales Premium

**SOMOS  
FABRICANTES  
DE ARTÍCULOS  
PROMOCIONALES  
TEXTILES DESDE 1989.**

**Promotier.mx**

**PPAI**  
The Mark of a Professional.

**SAGE**  
SUPPLIER MEMBER

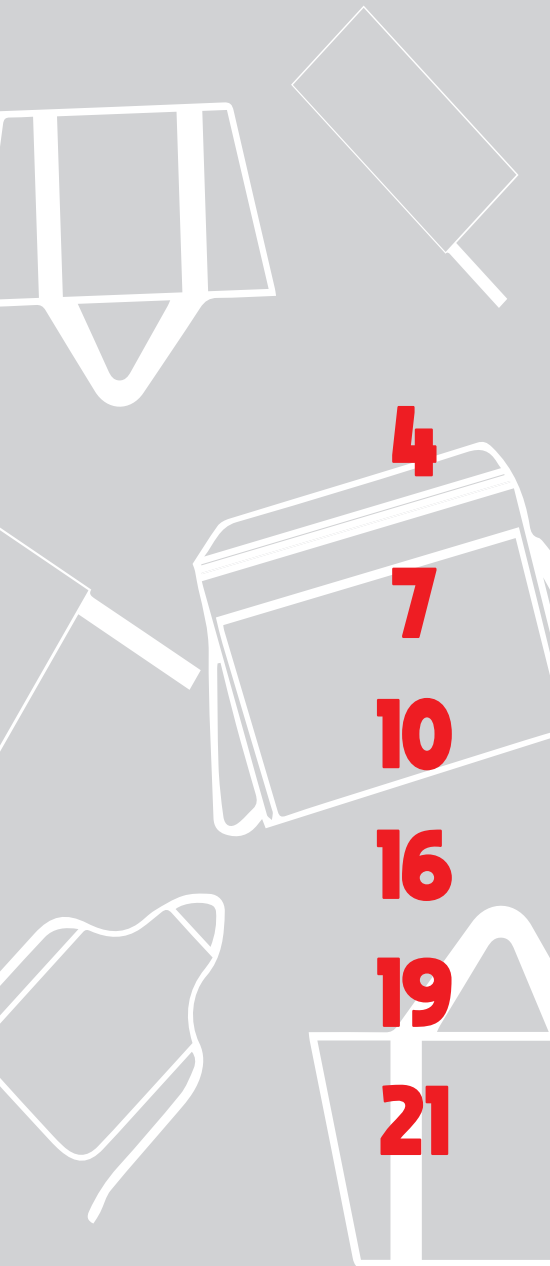

Información

Térmicos

Hieleras

Mandiles

Bolsas

Portafolios

# ÍNDICE

# ¿QUIÉNES SOMOS?

Somos una empresa líder en la fabricación de artículos promocionales textiles desde 1989. Somos fabricantes de loncheras, bolsas, hieleras, mandiles, portafolios, porta bebidas que puedes personalizar por completo.

## NUESTROS PRODUCTOS



Ofrecemos un portafolio de artículos promocionales innovadores y de la más alta calidad enfocados a las necesidad de nuestros clientes.



Te damos la oportunidad de escoger y personalizar nuestros productos a tu medida, para potenciar tus ideas al máximo.



Estamos comprometidos con los principios de desarrollo sustentable y la ecología.

## NUESTRA EXPERIENCIA

Ponemos a tu disposición mas de 30 años de experiencia siendo lideres en la fabricación de artículos promocionales textiles.

**30**  
**AÑOS**

## CONTROL DE CALIDAD

Nuestros productos son manufacturados con los mas altos estándares internacionales de calidad.

## MIX AND MATCH

Gran posibilidad de combinaciones a tu gusto.

CURPIEL	Black																		
NEOPRENO TERMICO	Black																		
ECOPRENO TERMICO	Black	White	Blue	Dark Blue	Red	Green													
CINTA	Black	White	Blue	Dark Blue	Red	Green	Grey	Yellow	Orange	Pink	Brown	Dark Brown							
HEAVY DUTY POLIESTER	Black	White	Blue	Dark Blue	Red	Green	Grey	Yellow	Orange	Pink	Brown	Dark Brown							
SOFT POLIESTER	Black	White	Blue	Dark Blue	Red	Green	Grey	Yellow	Orange	Pink	Brown	Dark Brown							
BIES	Black	White	Blue	Dark Blue	Red	Green	Grey	Yellow	Orange	Pink	Brown	Dark Brown							

## PROYECTOS ESPECIALES

Al ser fabricantes, le ofrecemos diferentes opciones de telas y diferentes colores, de modo que, tendrá usted la posibilidad de crear su propio estilo dentro de su negocio.



# PROYECTOS ESPECIALES



Te damos la oportunidad de personalizar nuestros productos a tu medida.



# Térmicos



# PORTABOTE TÉRMICO



# PORTAMEDIA TÉRMICO

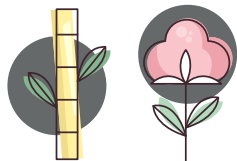

Material exterior Jersey  
Poliester. Interior isotérmico  
Scuba Foam Econeopreno



Portamedia térmico  
fabricado con bias y zipper  
tracero

Impresión de larga  
duración en serigrafía o  
dtf



Tiempo de fabricación  
y salida de 10 a 15  
días hábiles

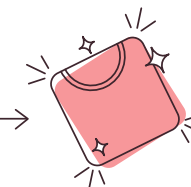

Pedido mínimo  
desde 50 pzs

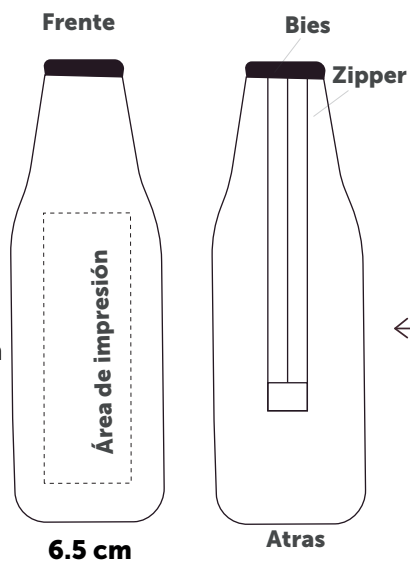

Colores de  
cuerpo &/o bias





# TORTILLERO TÉRMICO PARA RESTAURANTE

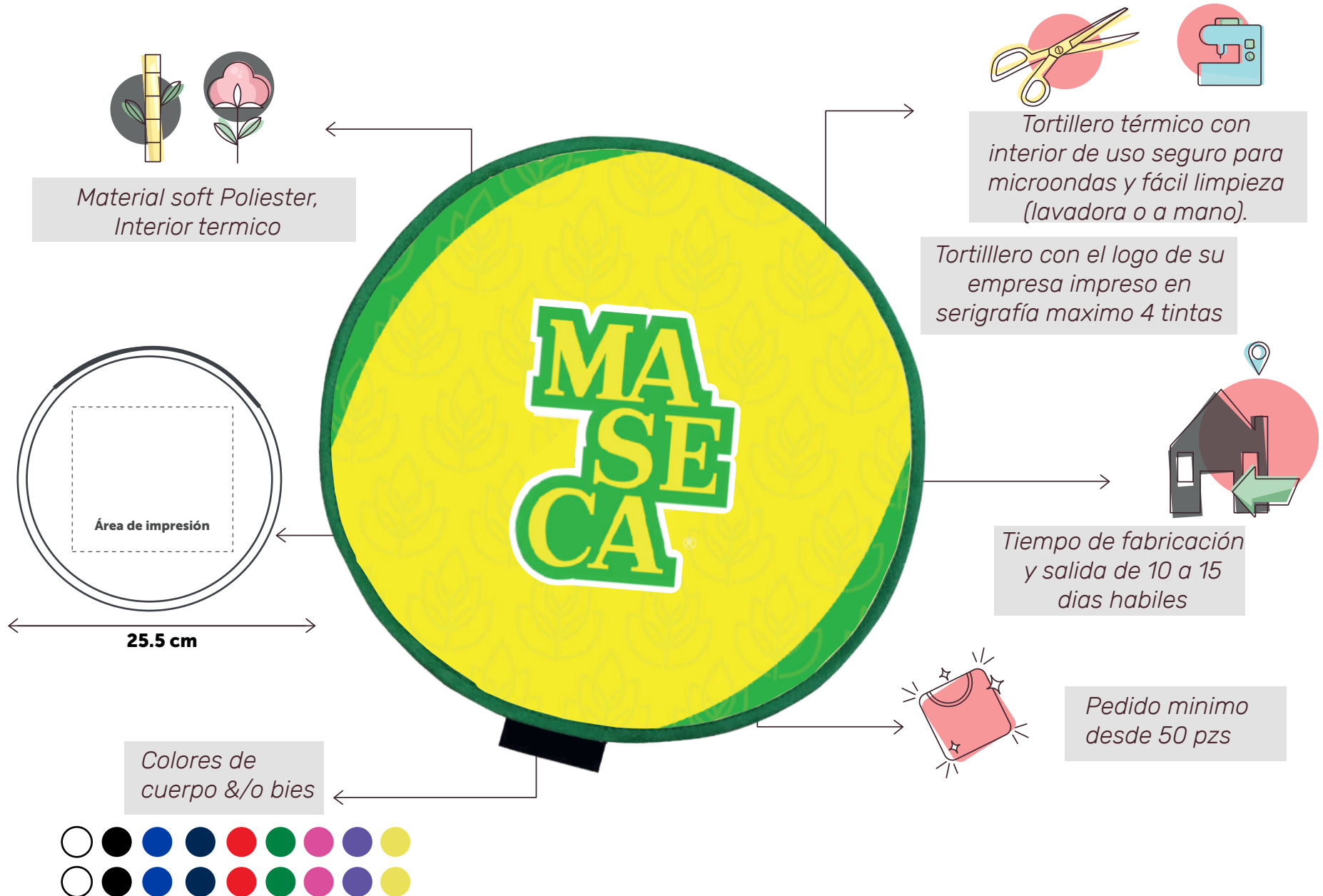

# TORTILLERO TÉRMICO PARA RESTAURANTE

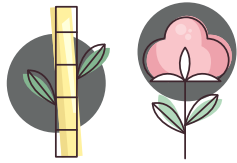

Material soft Poliester,  
Interior termico



Tortillero térmico con  
interior de uso seguro para  
microondas y fácil limpieza  
(lavadora o a mano).

Tortillero con el logo de su  
empresa bordado

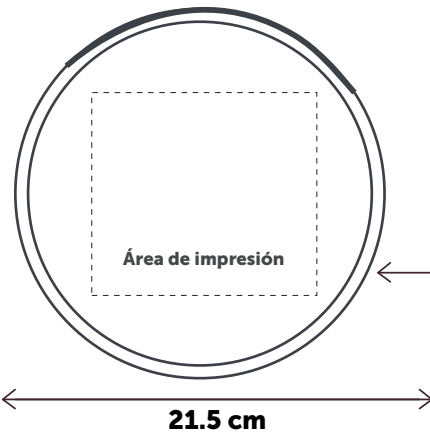

Tiempo de fabricación  
y salida de 10 a 15  
dias habiles

Colores de  
cuerpo &/o bias

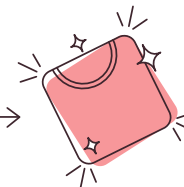

Pedido minimo  
desde 50 pzs



# TORTILLERO

## TÉRMICO SUBLIMADO

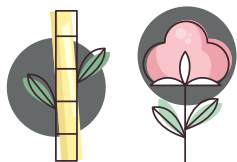

Material soft Poliester,  
Interior termico

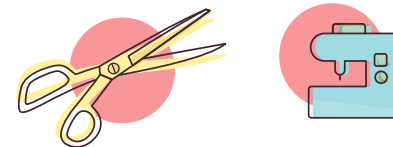

Tortillero térmico con  
interior de uso seguro para  
microondas y fácil limpieza  
(lavadora o a mano).

Impresion a todo color en  
sublimación



Tiempo de fabricación  
y salida de 10 a 15  
dias habiles

Pedido minimo  
desde 50 pzs

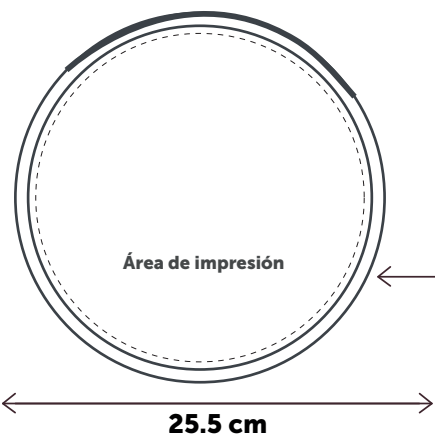

Colores de  
cuerpo &/o bias



# Hieleras



# BEACH BAG

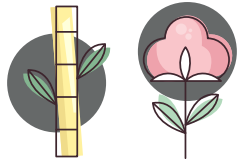

Material exterior Poliester Heavy Duty. Interior impermeable termoahulado 2 tipos de bolsa sellada. aprobadas por la FDA para contener alimentos.



Bolsa Hielera con doble compartimiento con espacio para 12 latas de 335 ml

Impresion de larga duraci3n en serigrafía o dtf



Agarradera

22 cm

Zipper

32 cm

Área de impresi3n

15 cm

**Rosarito**<sup>®</sup>  
Sabemos de sabor

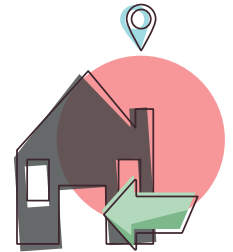

Tiempo de fabricaci3n y salida de 10 a 15 dias habiles

Colores de cuerpo & Zipper

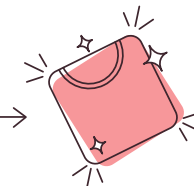

Pedido minimo desde 50 pzs

# HIELERA BAZOOKA

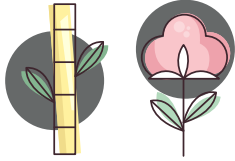

Material exterior Poliester Heavy Duty. Interior impermeable termoahulado 2 tipos de bolsa sellada. aprobadas por la FDA para contener alimentos.

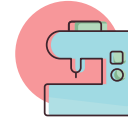
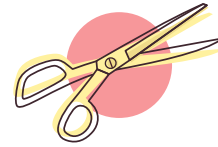

Hielera con agarradera y espacio para 6 latas de 335 ml

Impresion de larga duración en serigrafía o dtf

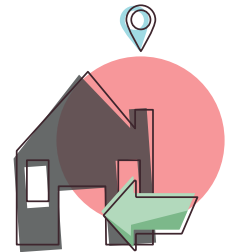

Tiempo de fabricación y salida de 10 a 15 días hábiles

Pedido minimo desde 50 pzs



Agarradera

Zipper de extremo a extremo

Área de impresión

47 cm

9 cm

Colores de cuerpo & Zipper



# HIELERA RECTANGULAR

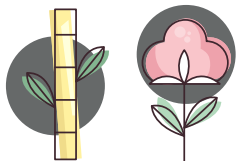

Material exterior Poliester Heavy Duty. Interior impermeable termoahulado 2 tipos de bolsa sellada. aprobadas por la FDA para contener alimentos.



Hielera rectangular con espacio para 6 latas de 335 ml

Impresion de larga duraci3n en serigrafía o dtf

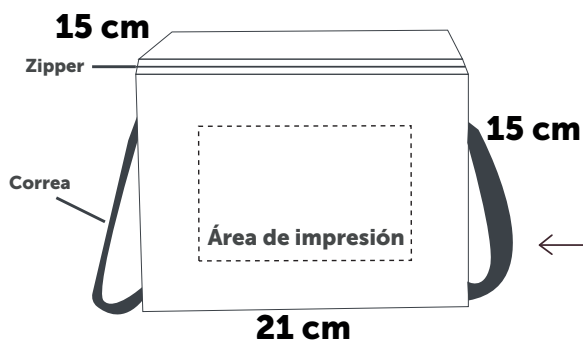

Tiempo de fabricaci3n y salida de 10 a 15 días hábiles

Colores de cuerpo & Zipper



Pedido minimo desde 50 pzs

# HIELERA 12

## RECTANGULAR

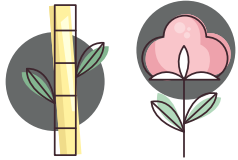

Material exterior Poliester Heavy Duty. Interior impermeable termoahulado 2 tipos de bolsa sellada. aprobadas por la FDA para contener alimentos.



Hielera rectangular con espacio para 12 latas de 335 ml

Impresion de larga duracion en serigrafía o dtf

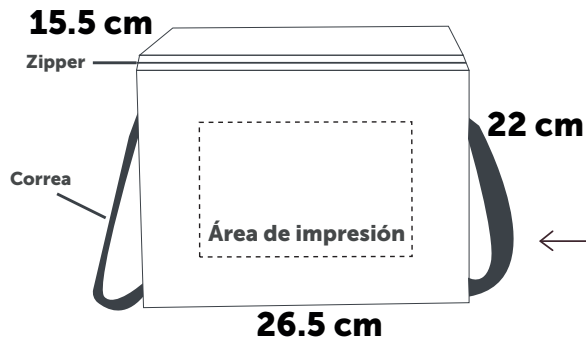

Tiempo de fabricación y salida de 10 a 15 días hábiles

Colores de cuerpo & Zipper

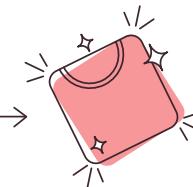

Pedido minimo desde 50 pzs



# HIELERA 24

## RECTANGULAR

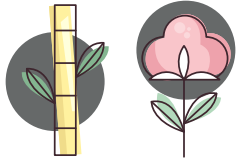

Material exterior Poliester Heavy Duty. Interior impermeable termoahulado 2 tipos de bolsa sellada. aprobadas por la FDA para contener alimentos.



Hielera rectangular con espacio para 24 latas de 335 ml

Impresion de larga duracion en serigrafía o dtf

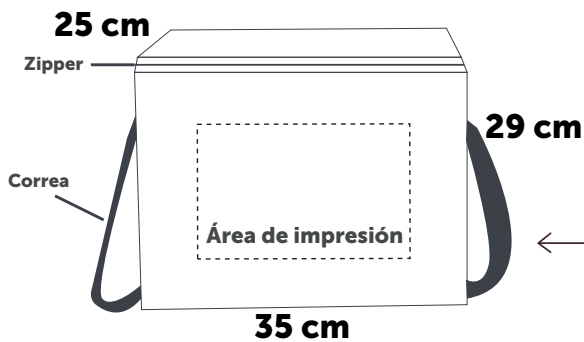

Tiempo de fabricación y salida de 10 a 15 días hábiles

Colores de cuerpo & Zipper

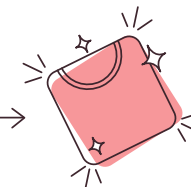

Pedido minimo desde 50 pzs



TODO CON MEDIDA

# HIELERA CILINDRICA

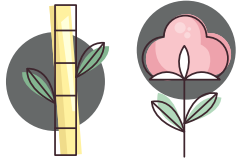

Material exterior Poliester Heavy Duty. Interior impermeable termoahulado 2 tipos de bolsa sellada. aprobadas por la FDA para contener alimentos.



Hielera cilindrica con espacio para 12 latas de 335 ml

Impresion de larga duracion en serigrafía o dtf

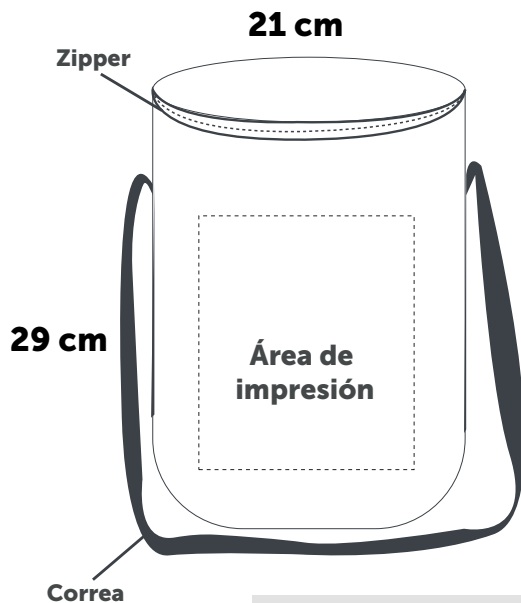

Colores de cuerpo & Zipper

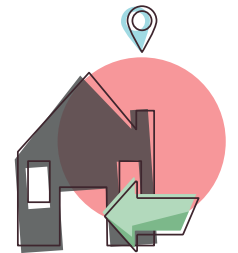

Tiempo de fabricación y salida de 10 a 15 días hábiles



Pedido minimo desde 50 pzs

# HIELERA 18 CILINDRICA

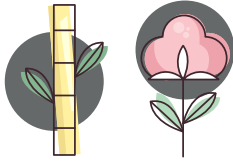

Material exterior Poliester Heavy Duty. Interior impermeable termoahulado 2 tipos de bolsa sellada. aprobadas por la FDA para contener alimentos.

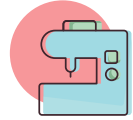
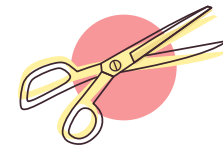

Hielera cilindrica con espacio para 18 latas de 335 ml

Impresion de larga duracion en serigrafía o dtf



Tiempo de fabricacion y salida de 10 a 15 dias habiles

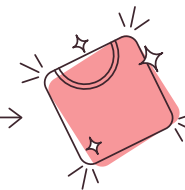

Pedido minimo desde 50 pzs

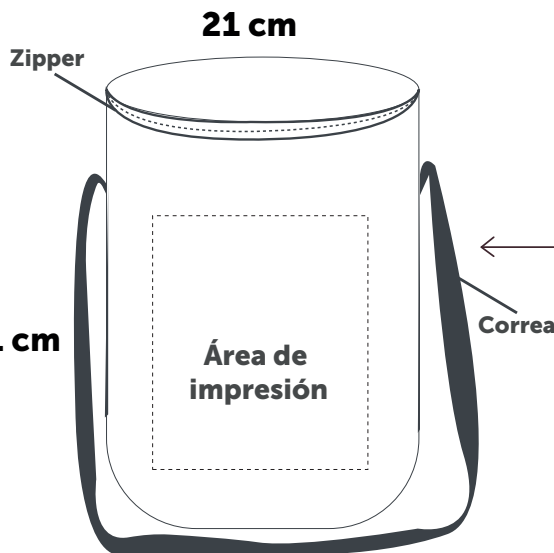

Colores de cuerpo & Zipper



# HIELERA VERTICAL

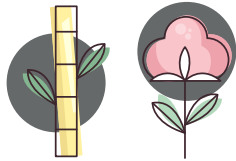

Material exterior Poliester Heavy Duty. Interior impermeable termoahulado  
2 tipos de bolsa sellada.  
aprobadas por la FDA para contener alimentos.

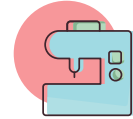
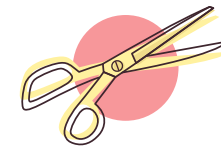

Hielera vertical con espacio para 12 latas de 335 ml

Impresion de larga duracion en serigrafía o dtf

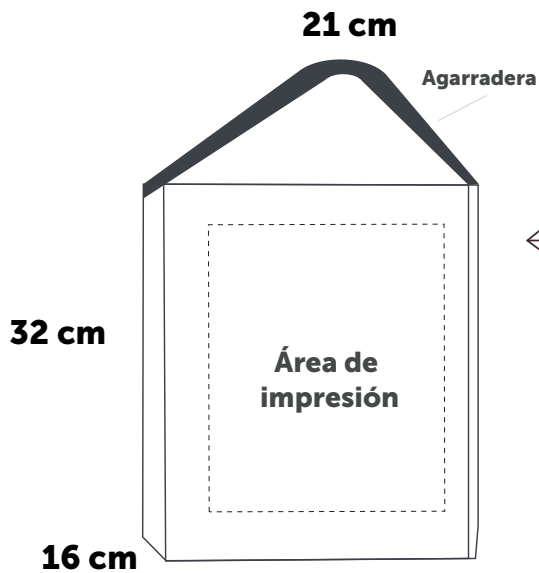

Colores de cuerpo & Zipper



Tiempo de fabricación y salida de 10 a 15 días hábiles

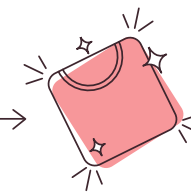

Pedido minimo desde 50 pzs

# Mandiles



# MANDIL TRIPLE-BOLSA

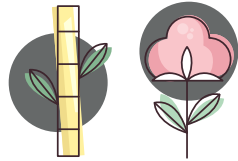

Tela Tergal

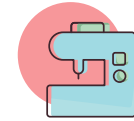

Mandil ligero y cómodo, combinable al gusto el color de tela y el bias incluye tres bolsas frontales inferiores.

Personalizalo en sefigrafía, transfer o DTF



Tiempo de fabricación y salida de 10 a 15 días hábiles

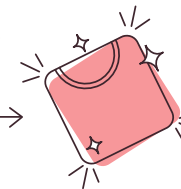

Pedido mínimo desde 50 pzs

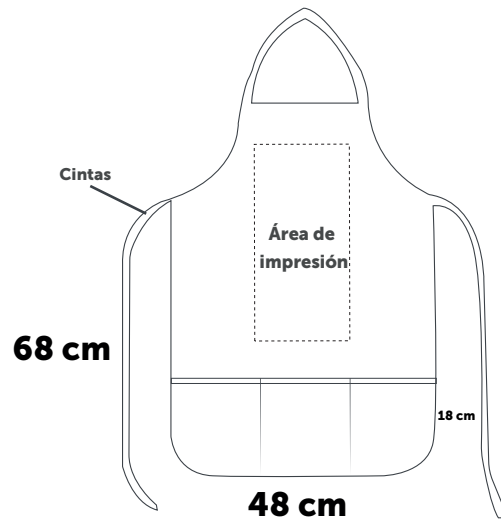

Colores de cuerpo & Bias



# MANDIL GABARDINA

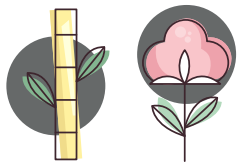

Tela Gabardina

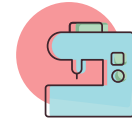

Mandil con correa ajustable  
en la parte superior

Personalizalo con  
Bordado o Serigrafía



Tiempo de fabricación  
y salida de 10 a 15  
dias habiles

Pedido minimo  
desde 50 pzs

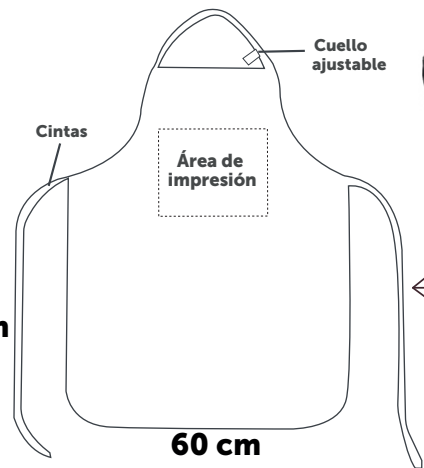

Color:



# MANDIL PARRILLERO

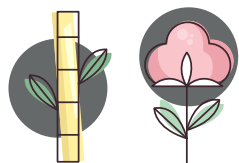

Tela Curpiel



Mandil ligero y cómodo con dos bolsas frontales.

Personalizalo en Bordado o serigrafía



Tiempo de fabricación y salida de 10 a 15 días hábiles

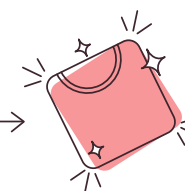

Pedido mínimo desde 50 pzs

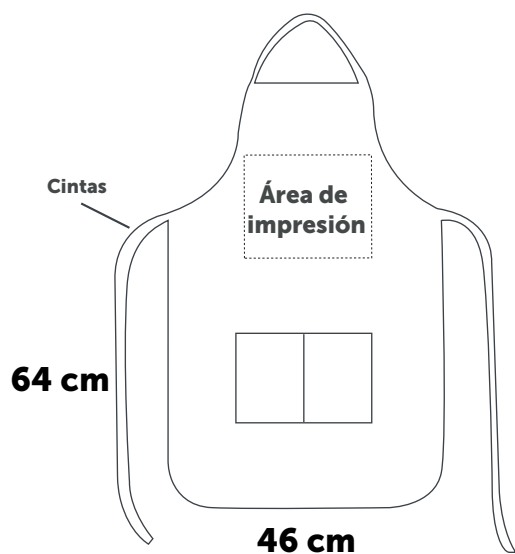

Color:





# MANDIL CORTO

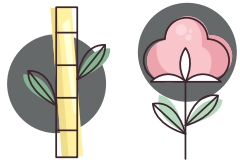

Tela Gabardina

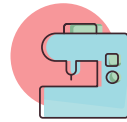
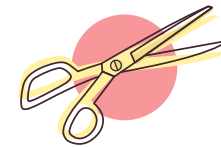

Mandil Corto o Mandil Mesero, clásico color negro, cuenta con bolsa frontal de 28 x 16 cm

Bordado



Tiempo de fabricación y salida de 10 a 15 días hábiles

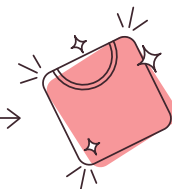

Pedido mínimo desde 50 pzs

Cintas

54 cm

Área de Bordado

50 cm

Color:



# Bolsas



# BOLSA MEGABAG

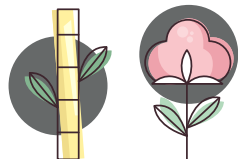

Poliéster Heavy Duty



Bolsa de gran capacidad y durabilidad. ideal para llevar al super

Personalízalo en serigrafía, transfer o DTF



Tiempo de fabricación y salida de 10 a 15 días hábiles

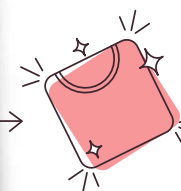

Pedido mínimo desde 50 pzs

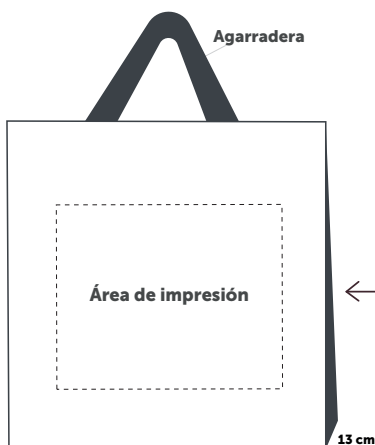

46 cm

Área de impresión

45 cm

13 cm

Colores de cuerpo & Cintas



# BOLSA DE PLAYA

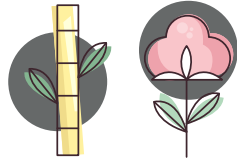

Poliéster Heavy Duty

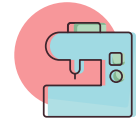
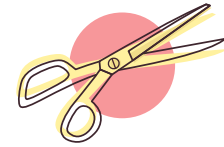

Bolsa completamente combinable, elige el color del frente, base y tirantes

Personalízalo en serigrafía, transfer o DTF



Tiempo de fabricación y salida de 10 a 15 días hábiles

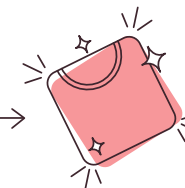

Pedido mínimo desde 50 pzs

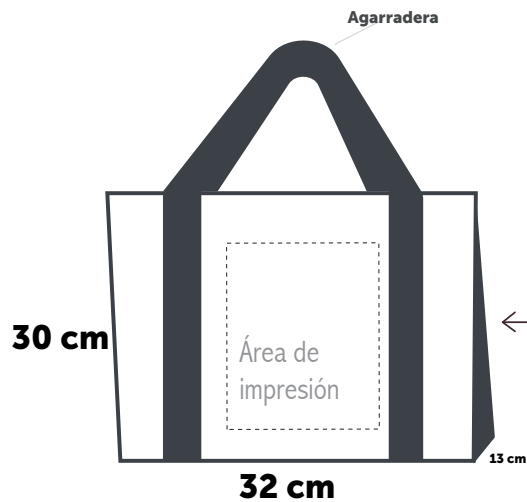

Colores de cuerpo & Cintas



# PORTAFOLIO SENCILLO

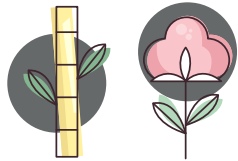

Poliéster Heavy Duty  
o vinil grueso

Colores de  
cuerpo & zipper



Portafolio sencillo (bank bag)  
con cierre superior y  
agarradera.

Personalízalo en serigrafía,  
transfer o DTF



Tiempo de fabricación  
y salida de 10 a 15  
días hábiles



Pedido mínimo  
desde 50 pzs

15 cm

Zipper

Área de impresión

20 cm

# PORTAFOLIO DOBLE

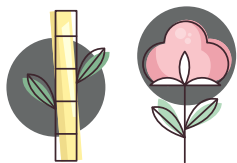

Poliéster Heavy Duty  
o vinil grueso

Colores de  
cuerpo & zipper



Portafolio (bank bag) con cierre superior y bolsa frontal, eligelo con o sin agarradera.

Personalízalo en serigrafía,  
transfer o DTF



Tiempo de fabricación  
y salida de 10 a 15  
días hábiles



Pedido mínimo  
desde 50 pzs

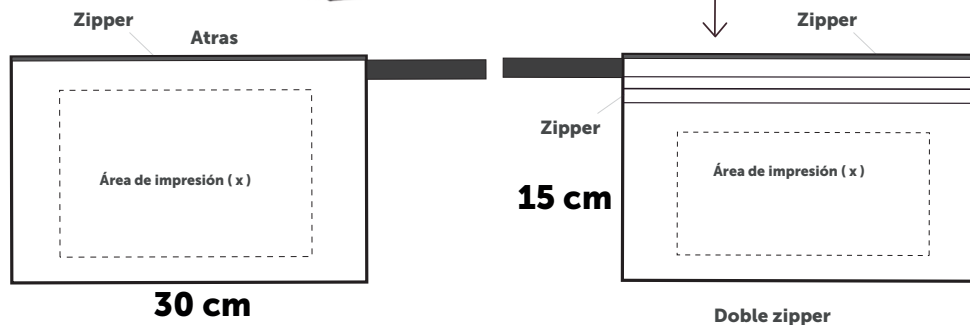

# LAPICERA SENCILLA

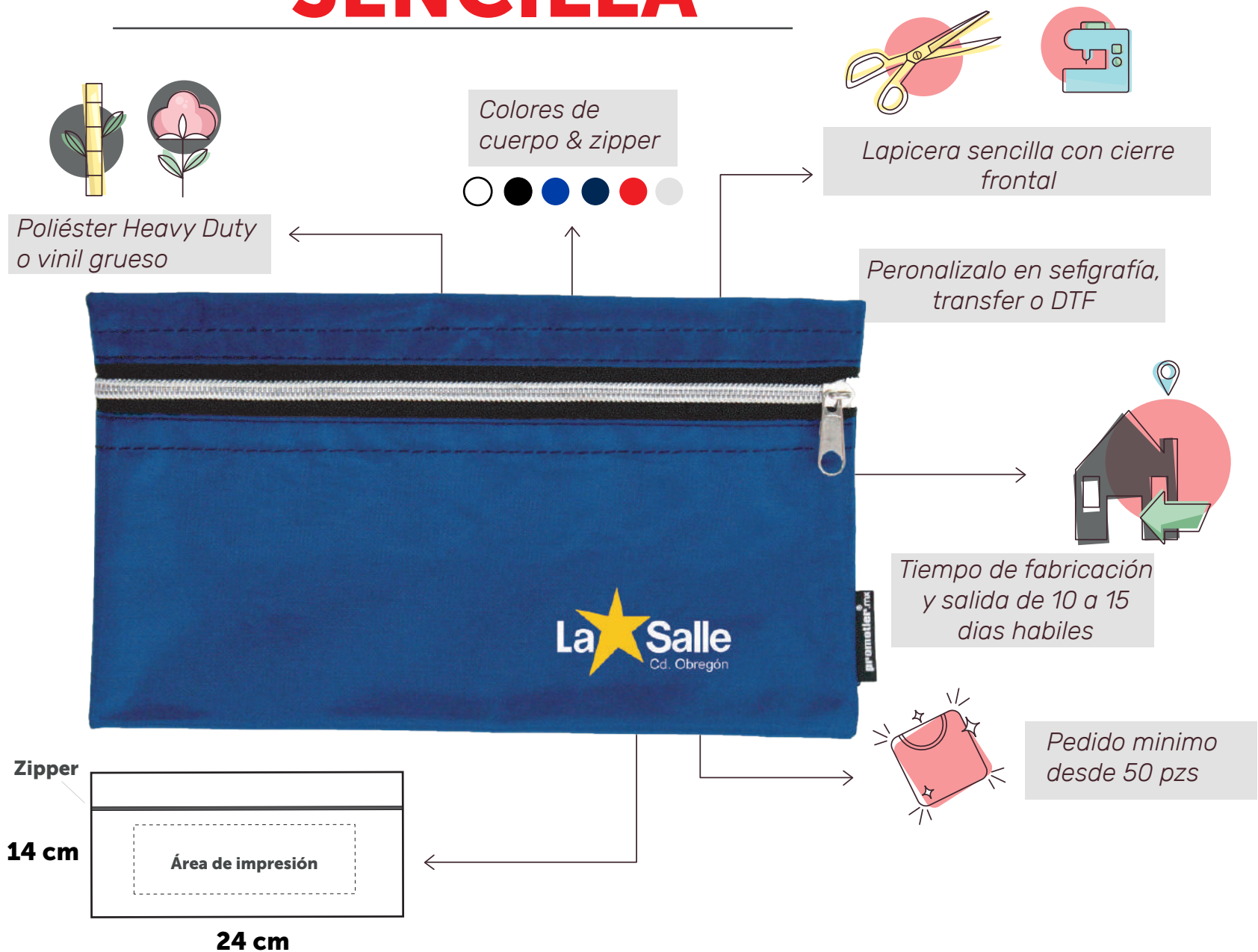



# PROMOTIER<sup>®</sup>

Promocionales Premium



**Escríbenos**

**ventas@promotier.mx**  
**proyectos@promotier.mx**



**WhatsApp**

**644 420 9169 / 56 4622 9998**



**Llámanos**

**644 420 9169 / 56 4622 9998**



**Visítanos**

**Bldv. Rodolfo Elías Calles**  
**1769-A, Cd. Obregón, Son.**